

Features

- Wide Band Cavity Band Pass Filter (28.6%)
- Very compact size and low weight
- Typical 0.3 dB Insertion Loss



Specifications

Parameter	Specifications	Remarks
Frequency Range	5,700 ~ 7,600 MHz	
Center Frequency	6,650 MHz	
Bandwidth	1,900 MHz	
Insertion Loss (Max.)	0.5 dB	
Pass Band Ripple (Max.)	0.3 dB	
Return Loss (Min.)	11.7 dB Min. (1.7:1 VSWR)	
Rejection (Min.)	86 dBc @ 1,000 MHz	
	50 dBc @ 10,500 ~ 16,300 MHz	
In/ Out Impedance	50 Ω	
Handling Power (Max.)	CW 1 W	
Temperature Range	-20 ~ +85 °C	
Dimensions	25.5 * 58.0 * 14.0 mm	Excluding Connectors
Connector	SMA (Female)	

Outline drawing

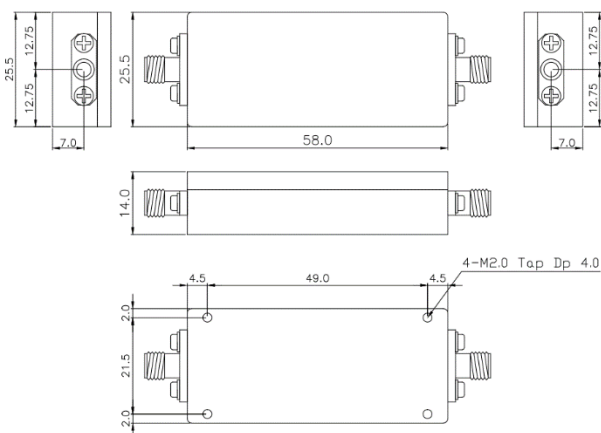

Typical Response

